







Parts list

<p>A</p>  <p>Integrated chair body : 1pc</p>	<p>B</p>  <p>Armrest : 1pair</p>	<p>C</p>  <p>Base : 1pc</p>
	<p>D</p>  <p>Gas lift : 1pc</p>	<p>E</p>  <p>Caster : 5pcs</p>
	<p>F</p>  <p>Hex wrench : 1pc</p>	<p>G</p>  <p>Screw : 3pcs(2pacs pre-installed) 1pc spare</p>

Safety Instructions

Please read the Safety Instructions below carefully

- 1 . Do not overload this chair. Each chair can only bear one person's weight at maximum.
- 2 . Please use it on a flat surface.
- 3 . Children under 5 years old should NOT use the chair.
- 4 . Please do not sit on the chair arm.
- 5 . Please do not stand on a chair or use it as a ladder/ trolley.
- 6 . Please do not use sharp things to scrape it or place it close to fire.
- 7 . Please do not put your fingers in between the chair while using it.

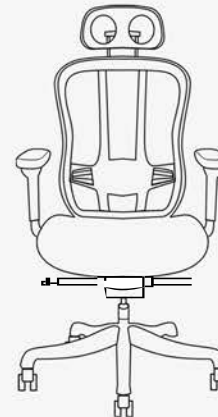

Solos Premium Ergonomic Chair

SOLOS

SO-EC001-BK

www.solso-it.com
sales@solso-it.com

Installation

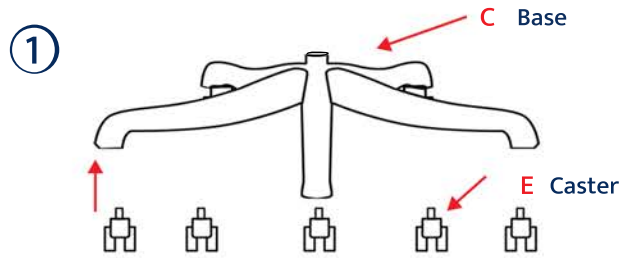

Step 1 : Put the casters into the holes at the end of each base leg.

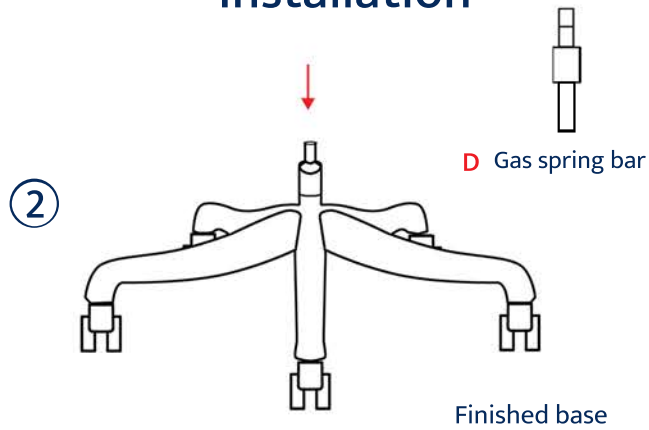

Step 2 : Insert the gas lift into the center hole of the starbase.

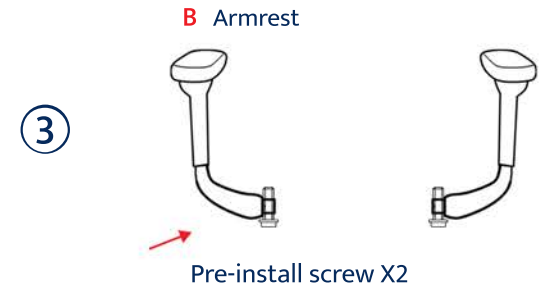

Step 3 : Pull out the pre-installed screws from the armrest.

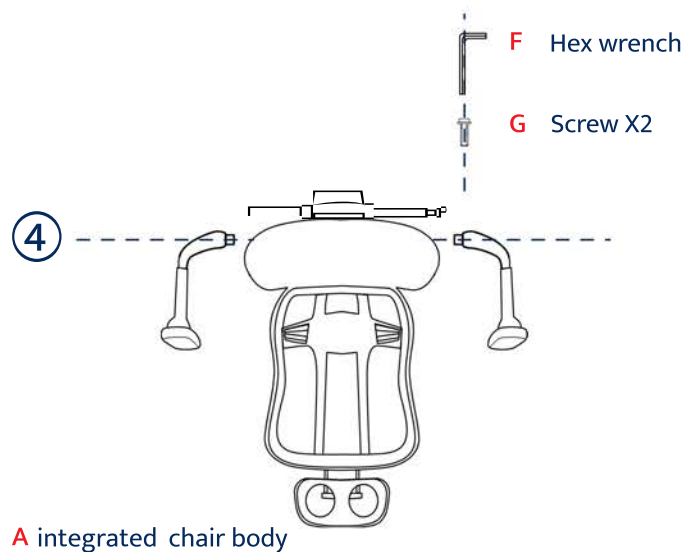

Step 4 : Screw the arms into the seat plate under the seat cushion.

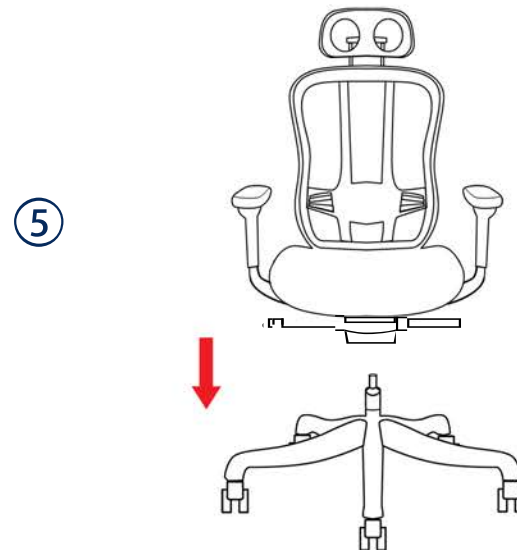

Step 5 : Attach the whole seat to the star base.

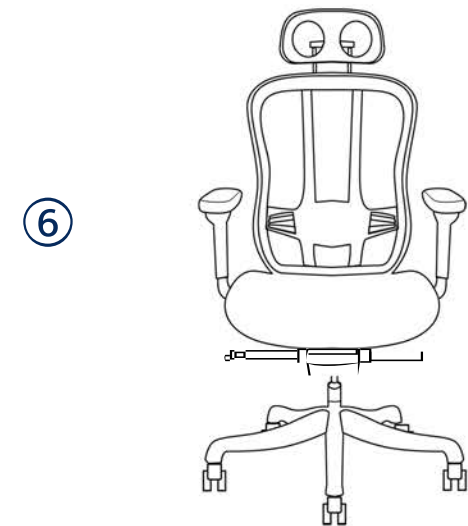

Finished product