

SOLOS

TeleConference

User manual

Component Instruction

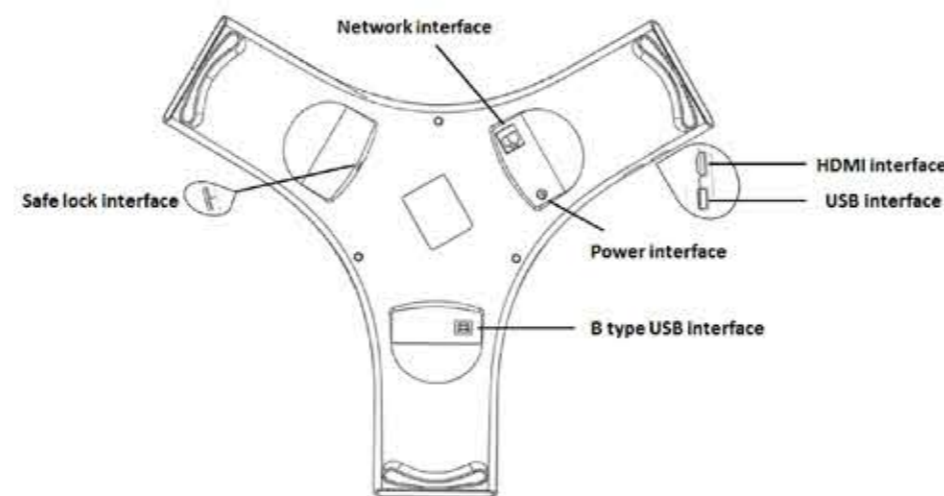
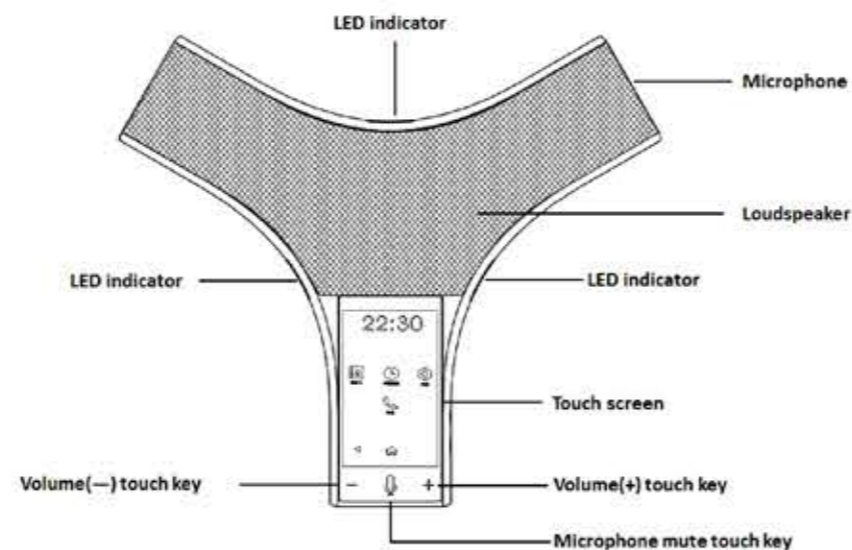

LED Indicator status:
 RED: Microphone mute
 GREEN: Normal working

ENGLISH

Packing list

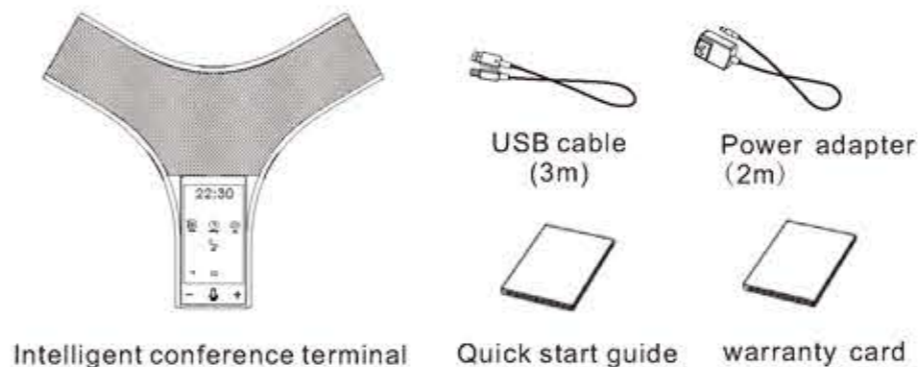

Assembling

1. Connect the power and wired network

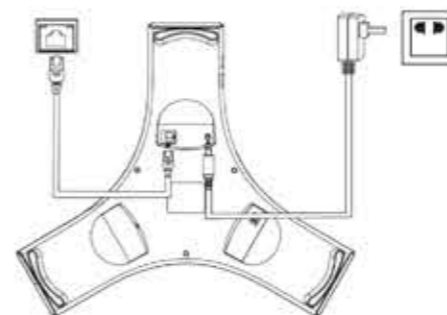

2. USB connection

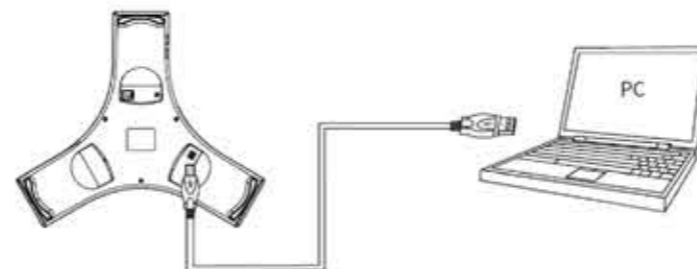

ENGLISH

3. HDMI connection

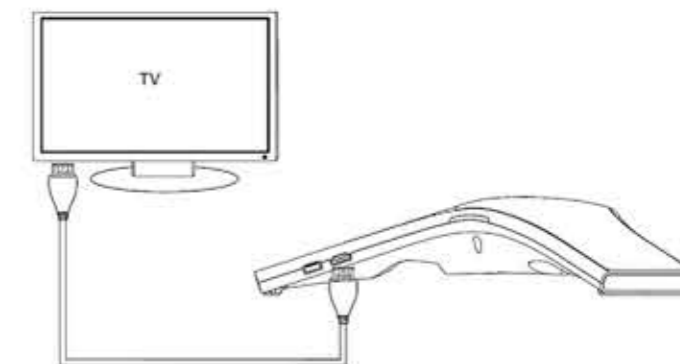

4. Extend camera or mouse connection

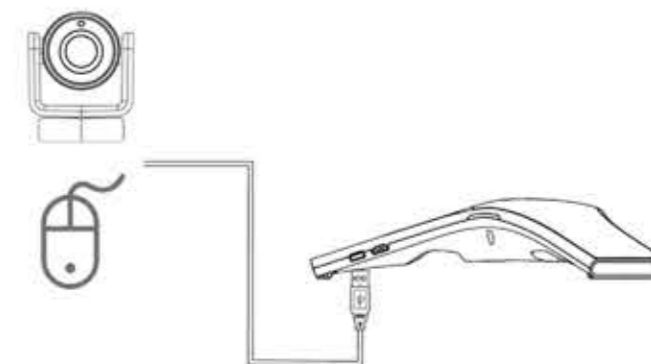

5. Security slot connection

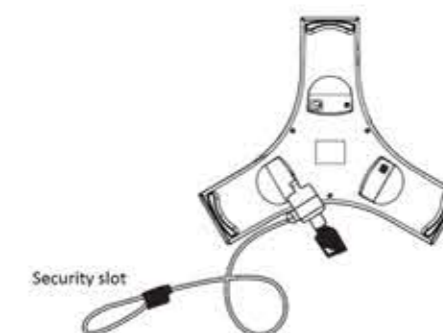

ENGLISH